

Assembly instructions DCL-PAR114

NOTE:

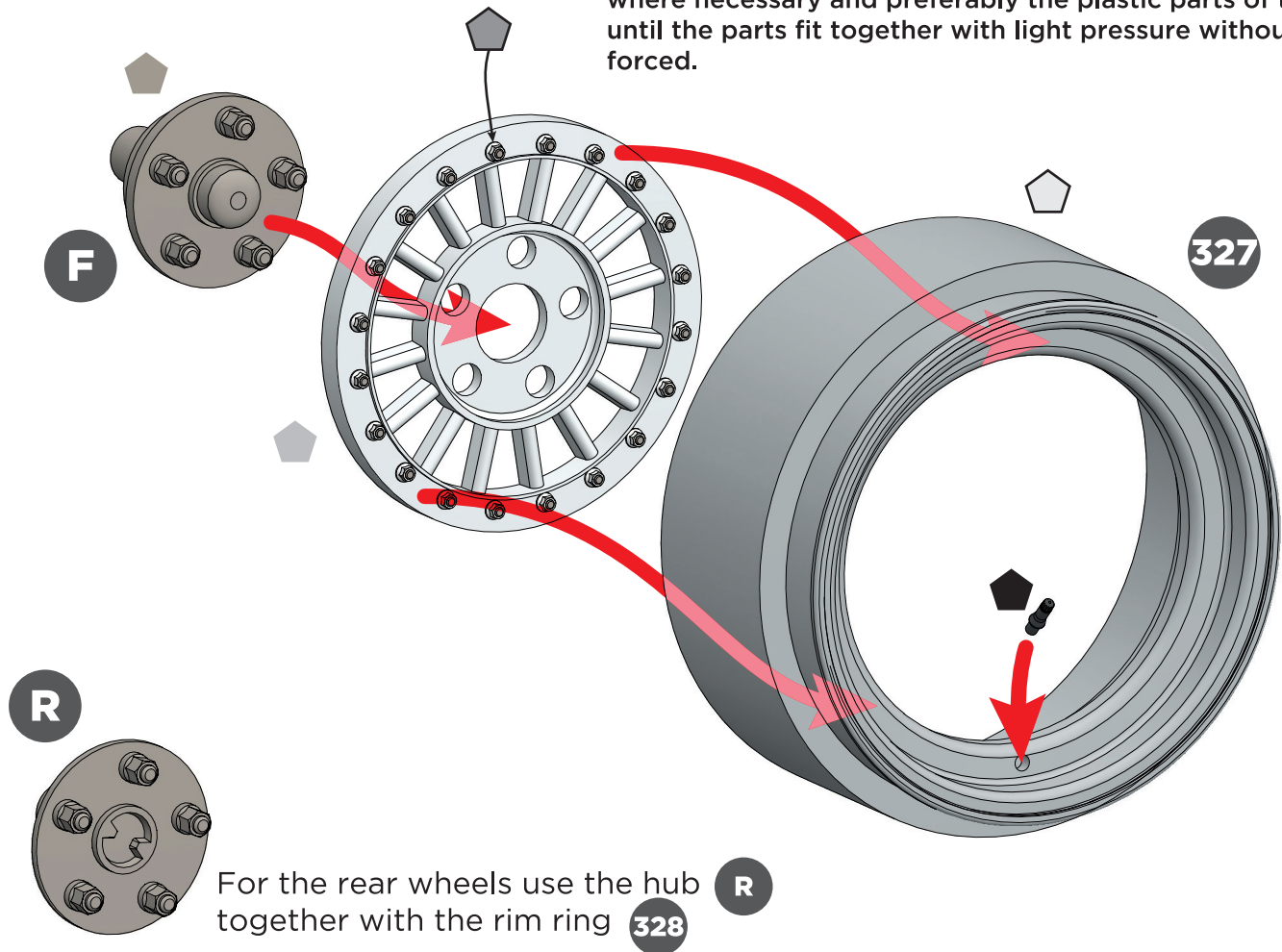





3D resin is fragile, so you should NOT use excessive force when joining the pieces or you risk breaking the parts. Carry out a test assembly before painting the parts, sanding where necessary and preferably the plastic parts of the kit, until the parts fit together with light pressure without being forced.

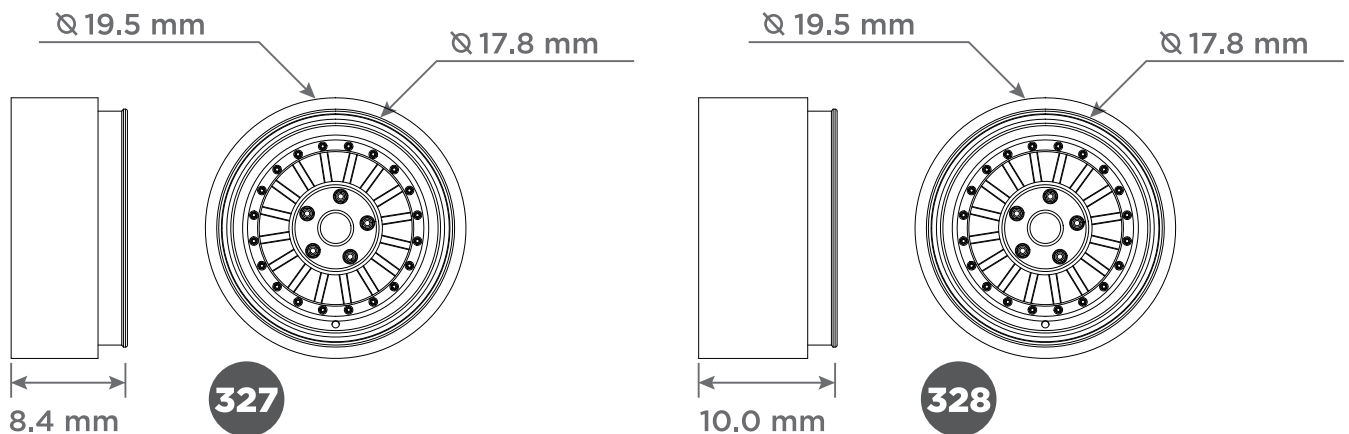

Parts dimensions



Paints required

-  TYRE BLACK (N5-X070 by Number Five)
-  STEEL (N5-C054 by Number Five)
-  WHITE ALUMINIUM RAL9006 (N5-X019 by Number Five)
-  TITANIUM EXHAUST (N5-X068 by Number Five)
-  AK SUPER CHROME (AK9198 by AK Interactive)